

# **HIGH SPEED DOME OPERATION MANUAL**

Please read this manual thoroughly prior to installation and operation

---

## Contents

<b>Precautions</b> .....	<b>2</b>
<b>1 Product Introduction</b> .....	<b>3</b>
<b>1.1 Specifications of Dome Drive and Housing</b> .....	<b>4</b>
<b>1.2 Camera Specifications</b> .....	<b>5</b>
<b>2 Installation</b> .....	<b>6</b>
<b>2.1 Accessory Check</b> .....	<b>6</b>
<b>2.2 Dipswitch Setup</b> .....	<b>6</b>
<b>2.2.1 Dome Address Setup</b> .....	<b>6</b>
<b>2.2.2 Protocol and Baud Rate Setup</b> .....	<b>6</b>
<b>2.2.3 Alarm Trigger Mode Setup</b> .....	<b>7</b>
<b>2.2.4 Camera Module Installation</b> .....	<b>7</b>
<b>2.3 Wire Connections</b> .....	<b>8</b>
<b>2.4 Installation Procedures</b> .....	<b>9</b>
<b>2.4.1 Mount/Dismount Dome Drive in Housing</b> .....	<b>9</b>
<b>2.4.2 Mount/Dismount Lower Dome</b> .....	<b>9</b>
<b>2.4.3 Mount to a Support</b> .....	<b>10</b>
<b>2.4.4 Install the Entire Unit</b> .....	<b>10</b>
<b>2.4.5 Power on and Speed Dome Self-testing</b> .....	<b>10</b>
<b>3 Operation</b> .....	<b>11</b>
<b>Appendix 1: Dome Camera Address Table</b> .....	<b>12</b>

## Precautions

1. Please read this manual thoroughly prior to installation and operation. Store this manual properly for future reference. Consult your speed dome camera dealer if you have uncertainties or questions.
2. Make sure to use correct power supply indicated in the specifications. Wrong power supply may cause improper performance, damage of the product, or fire. It is recommended that you use the power supply that your speed dome dealer may provide.
3. The High-Speed Dome Camera contains precision optical and electrical instruments. To avoid possible damage caused by striking or shocking, please handle the unit carefully during delivery, storage and installation.
4. In the case of any unusual performance, unplug the unit and contact your dealer immediately for help. Do not disassemble or remove any internal parts of the unit without professional help.
5. To ensure optimal performance, make sure there is enough distance between video cable and RS485 wires from the unit and any local high-voltage equipment or cables.
6. Please do not install and use the unit in an environment with temperature or humidity that exceeds the restrictive limits listed in the specifications.
7. To avoid damage to camera's CCD, do not aim the camera at the sun or very bright object and do not aim at bright object for a long time even when power is off.
8. Do not use any strong chemical liquids when cleaning. If necessary, use neutral detergent and water to clean the housing and lower bubble, and gently dry them off with soft cotton fabric.
9. Always install the unit in a place with enough holding force to avoid dropping the unit. The required minimum holding force is five times of the total weight of the unit and the support.
10. Always use special optical lens paper or fabric to clean lens.
11. Wear cotton gloves when handling dome bubble during installation or disassemble to avoid bubble surface being scratched.

## 1. Product Introduction

The high-speed dome camera is CCTV front-end equipment with high price value ratio. The product has the following main features.

- Extra-durability reduces rate of failure. High cost un-installation and re-installation jobs are significantly diminished, which is why we offer a three-year warranty for our product.
- Since most of the high-speed dome failure is due to power supply failure, we offer optional high standard power supply. The tested failure rate of the power supply is less than 1‰.
- Power supply is separated from the high-speed dome for easy un-installation. Thus if there is a power supply failure, one can replace power supply without un-installing the speed dome.
- Easy camera module installation gives OEM customer more flexibility to choose camera modules. Currently the high-speed dome supports Sony, Hitachi, and LG camera modules.
- This system is compatible with all control devices that support Pelco protocols.
- Convenient dip switches allows customer to set camera module, protocol, baud rate and address without taking speed dome out from housing.
- Apply non-linear step shredding technology (patent pending) to achieve accurate positioning and to obtain outstanding performances in both slow and fast movements.
- Simple fast-installation scheme allows user to mount speed dome core to housings easily and therefore allows OEM customers to choose or develop their own housings.
- Multi-level optimization makes the circuit boards and entire structure compact with low noise and low heat generation during operation which furthermore enhances the durability of the product.

## 1.1 Specifications of Dome Drive and Housing

Model	407	417	607
Product Name	Outdoor speed dome		Indoor speed dome
Pan movement	0° ~ 360° continuous		
Tilt movement	+1° ~ - 90°		
Pan speed/sec	0.1° to 270° variable		
Tilt speed/sec	0.1° to 90° variable		
Presets	228		
Preset tours	8		
Communication	RS485 interface		
ID address	1 ~ 256 address		
Protocols	Pelco D, Pelco P		
Baud rate	1200 / 2400 / 4800 / 9600/ 19200 bps selectable		
auto-flip	180° auto-flip at tilt 90°		
Auto-speed	Pan and tile speeds are automatically adjusted according to zoom		
Scanning	Can be set up between any two points		
Scanning speed	Adjustable (64 levels)		
Dwell time	1-60 sec adjustable		
Power Source	DC12V /1A or AC24V/500mA (no heater)		
Heater Power	AC24V/3A		
IP RATING	IP66		Not rated
Operating Temp	-40□(-40□) to +60□(+140□)		0□(32□) to +40□(104□)
Dimensions	D: 260mm (10"); H: 350mm (14")	D : 201 mm (8") H: 332mm(13")	D:222mm(9"); H:280mm(11")
Weight	3.5kg (7.7lb)	3.4kg (7.5lb)	1.6kg (3.5lb)

## 1.2 Camera Specifications\*

### SPECIFICATIONS OF L SERIES CAMERA MODULES\*

Sub-Model	L2210	L2210L	L2610D	L2710D
Image Device	1/4" Super HAD CCD	1/4" Super HAD CCD	1/4" Super HAD CCD	1/4" Super HAD CCD
Picture Element	NTSC: 380,000 pixels; PAL: 440,000 pixels	NTSC: 380,000 pixels; PAL: 440,000 pixels	NTSC: 380,000 pixels; PAL: 440,000 pixels	NTSC: 380,000 pixels; PAL: 440,000 pixels
Sync-sync	Internal / External	Internal / External	Internal / External	Internal / External
Auto White Balance	Auto / ATW	Auto / ATW	Auto / ATW	Auto / ATW
Min. Illum. (color)	1.0 lx	1.0lx	1.0 lx	1.0lx
Min Illum (b/w)	—	0.1 lx	0.1 lx	0.1lx
Lens	F=1.6 ~3.7 (f=3.9 to 85.8mm 22 x Optical, 16x digital)	F=1.6 ~3.7 (f=3.9 to 85.8mm 22 x Optical, 10x digital)	F1.6~F3.0 (f=3.9 to 91mm 26X optical 10x digital)	F=1.5 to F3.6 (f=3.25 to 88mm 27x optical, 10x digital)
Resolution	480TVL	480TVL	480TVL	480TVL
S/N Ratio	>48 dB	>48dB	48 dB	>48dB
Electro-shutter	auto/manual 1/50~1/10,000s	auto/manual 1/60~1/10,000s	auto/manual 1/50~1/10,000s	auto/manual 1/1.5~1/10,000s
Focus Control	auto/manual	auto/manual	auto/manual	auto/manual
Iris Control	auto/manual	auto/manual	auto/manual	auto/manual
WDR	—	No	—	No
Day/Night	—	Yes **	Yes	Yes
Scan Mode	2:1 interlaced scan	2:1 interlaced scan	2:1 interlaced scan	1:1 non-interlaced scan
Dimensions (mm)	47.2×55.5×89.5	60x60.3x101.1	50.5x61.1x92.25	47.2×55.5×89.5

\*\*Electronic day/night, not IR cut filter removable.

**SPECIFICATIONS OF S SERIES CAMERA MODULES\***

Sub-Model	S2212	S1812	S1812L	S1812D
Image Device	1/4" CCD	1/4" Super HAD CCD	1/4" EXview HAD CCD	1/4" EXview HAD CCD
Picture Element	NTSC: 380,000 pixels; PAL: 440,000 pixels			
Sync-sync	Internal / External			
Auto White Balance	Auto / ATW			
Min. Illum. (color)	1.0 lx	1.0 lx	0.7lx	0.7lx
Min Illum (b/w)	—	—	—	0.01lx
Lens	F=1.6 ~3.8 (f=4 to 88mm 22 x Optical, 12x digital)	F1.4~F3.0 (f=4~ 74mm 18X optical 12X digital)	F1.4 ~F3.0 (f=4 ~ 74mm 18X optical, 12X digital)	F1.4 ~F3.0 (f=4 ~ 74mm 18X optical, 12X digital)
Resolution	470TVL	460TVL	480TVL	480TVL
S/N Ratio	>50 dB	> 50 dB	>50 dB	>50 dB
Electro-shutter	auto/manual 1/50~1/10,000s	auto/manual 1/50~1/10,000s	auto/manual 1/1~1/10,000s	auto/manual 1/1~1/10,000s
Focus Control	auto/manual	auto/manual	auto/manual	auto/manual
Iris Control	auto/manual	auto/manual	auto/manual	auto/manual
WDR	No	No	No	No
Day/Night	No	No	No	Yes
Scan Mode	2:1 interlaced scan	2:1 interlaced scan	1:1 non-interlaced scan	1:1 non-interlaced scan
Dimensions (mm)	50x60x89.5	48.2×56.5×92.3	50×57.5×88.5	50×57.5×88.5

**SPECIFICATIONS OF More S SERIEES CAMERA MODULES \***

Sub-Model	S2310D	S2612D	S3612D	S3512D	S2612DS
Image Device	1/4" CCD	1/4" EXview HAD CCD	1/4" EXview HAD CCD	1/4" CCD	1/4" EXview HAD CCD
Picture Element	NTSC: 380,000 pixels; PAL: 440,000 pixels				N: 680K; P:800K
Sync-sync	Internal / External				
Auto-White Balance	Auto / ATW				
Min. lux. (color)	3.lx	1.0lx	1.4lx	0.5 lx	2.0 lx
Min lux (b/w)	0.02lx	0.01lx	0.01lx	0.01lx	0.01lx
Lens	F=1.6 ~3.8 (f=3.6~82.8 mm 23 x Optical, 10x digital)	F1.6 ~F3.8 (f=3.5~ 91mm 26X optical, 12X digital)	F1.6 ~F4.5 (f=3.4 ~ 122.4mm 36X optical, 12X digital)	F1.6 ~F3.8 (f=3.4~ 119mm 35X optical, 12X digital)	F1.6 ~F3.8 (f=3.5~ 91mm 26X optical, 12X digital)
Resolution	470TVL	480TVL	480TVL	540TVL	480TVL
S/N Ratio	>50 dB	>50 dB	>50 dB	>50 dB	>50 dB
Electro-shutter	auto/manual 1/1~1/10,000s	auto/manual 1/1~1/10,000s	auto/manual 1/1~1/10,000s	auto/manual 1/1~1/10,000s	auto/manual 1/1~1/10,000s
Focus Control	auto/manual	auto/manual	auto/manual	auto/manual	auto/manual
Iris Control	auto/manual	auto/manual	auto/manual	auto/manual	auto/manual
WDR	Yes	No	No	Yes	No
Day/Night	Yes	Yes	Yes	Yes	Yes
Scan Mode	1:1 non-interlaced scan	1:1 non-interlaced scan	1:1 non-interlaced scan	1:1 non-interlaced scan	1:1 non-interlaced scan
Dimensions (mm)	50x60x89.5	52×57.5×88.5	50×57.5×87.9	50x60x89.5	52×57.5×88.5

\* Detail data are available upon request.

## 2. Installation

### Accessories Checking

Prior to installation, please make sure all accessories are available. Contact your YAAN dealer immediately if any accessories are missing or damaged.

	Item	407	417	607
1	Decoration Ring	-		1
2	Power supply(optional)	1		
3	Alarm adapter	1 (installed if wires are provided)		
4	User's manual	1		

For the convenience of RMA service, please store all original packing materials properly.

### Dipswitch Setup

Before installation, first set up dome address, protocol, and baud rate correctly. Dome address, protocol and baud rate can be set up through adjusting dipswitches on the dome drive. Refer to the following figure to locate the two dipswitch sets, SW1 and SW2 on the dome drive. Each of the sets contains eight dipswitches with SW1 for camera address and SW2 for protocol and baud rate.

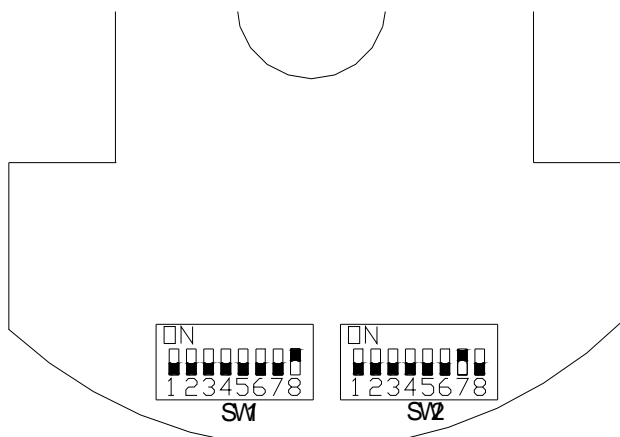





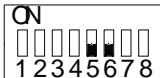

#### 2.2.1. Dome Address Setup

Dome address can be set to any number from 1 to 255. Refer to the following chart in appendix 1 for corresponding address and dipswitch positions.

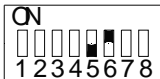
#### 2.2.2. Protocol and Baud Rate Setup

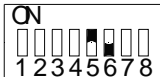
Use SW2 and refer to the following figure to set up protocol and baud rate. Switch 3 and 4 are for protocol setup; while 5 and 6 are for baud rate

Dipswitch Positions	Communication Protocol	Dipswitch Positions	Communication Baud rate
	ASEC		1200BPS
	PELCO D		2400BPS
	PELCO P		4800BPS
	Reserved		9600BPS

### 2.2.3 Alarm Triggering Mode Setup

The speed dome system has two alarm triggering modes: MANUAL mode and AUTO mode. Use #1 dipswitch (manual alarm switch) on SW2 to set up alarm triggering mode as shown in the following figure.

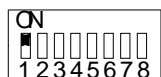

MANUAL mode: Turn the switch on. Four channel alarms can be set up to on-duty or to off-duty manually through control device (keyboard, DVR, etc.). Refer to manual of control device for more details.



AUTO mode (default): Turn off the switch. Four channel alarm inputs are automatically on full time duty.

**Attention: AUTO model is default mode and is suggested for use of most applications. When switching to manual mode, it is very important to test your control device to make sure that manual mode works properly before any installation.**

The four alarm inputs (AL1, AL2, AL3 and AL4) correspond to the first four presets of the speed dome system. When alarms are on-duty and an alarm input is triggered (e.g., AL1), the corresponding preset (i.e., preset #1) will be recalled. If more than two alarm inputs are triggered simultaneously, a preset tour will be performed between the presets that correspond to the triggered alarm inputs.

When no alarm is triggered, the alarm output replay is closed. If an alarm is triggered, the alarm output replay opens for two minutes and then closes again.

### 2.2.4 Camera Module Installation

**Note: This section is for product dealer only. End users or installers shall not install or uninstall camera module by themselves.**

The speed dome system supports camera modules made by Sony, Hitachi, LG or CNB. Use four M1.7 screws (provided with camera module) to mount the camera module on the camera frame of the speed dome and connect the flexible flat cable. Use the following table to find the positions of 7<sup>th</sup> and 8<sup>th</sup> dipswitches in SW2 for different brand of cameras.

Camera Module	7 <sup>th</sup> dipswitch of SW2	8 <sup>th</sup> dipswitch of SW2
Sony	OFF	OFF
CNB	OFF	ON
Hitachi	ON	OFF
LG	ON	ON

## 2.3 Wire Connections

Wire connection board is on the back of speed dome drive. Refer the following figure to connect wires (if wires are provided, please refer to wire end labels for connection).

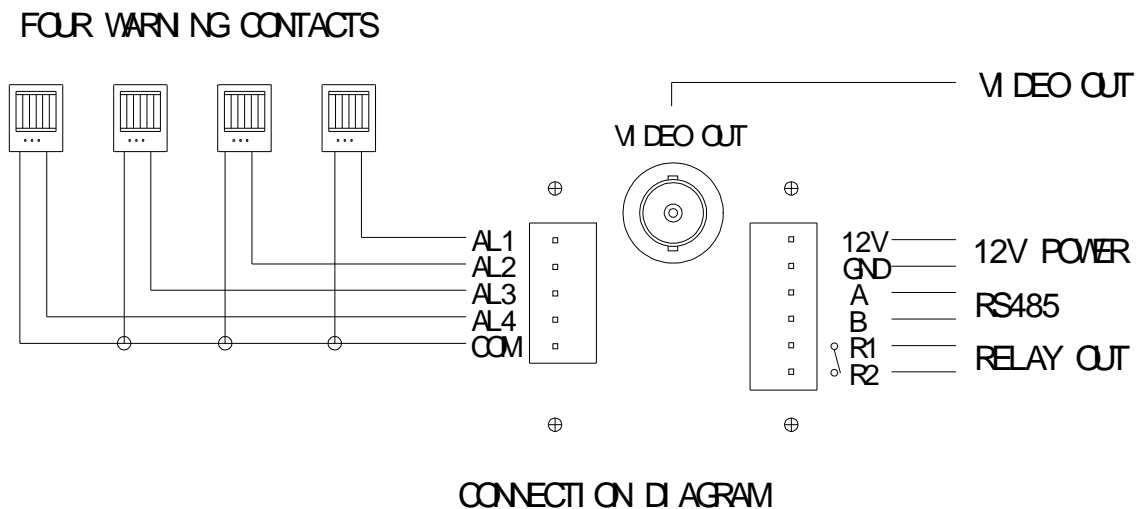

VIDEO OUT: to video BNC

12V: to the positive terminal of +12VDC power supply

GND: to the ground terminal of power supply

A: to RS485 +

B: to RS485 –

R1 and R2: to alarm output relay

AL1, AL2, AL3, AL4; to alarm inputs.

**Note: If labeled wires are provided and are already connected to the speed dome unit, user only needs to connect the wires to power supply, monitor, control device and alarm devices. Please pay attention to color codes on the labels, especially when connecting 12VDC.**

## 2.4 Installation Procedures

### 2.4.1 Mount/Dismount Dome Drive in Housing

Dome drive and housing are already assembled together and end users are advised against mounting or dismounting dome drive in housing by themselves; this section is only for dealer's reference.

Before mounting the dome drive into housing, make sure wires are correctly and firmly connected to dome drive.

Carefully mount the two screw holes on each side of dome drive into the two screws on the mounting plate in the housing. Turn the dome drive clockwise until the ends of the two holes reach the screws and tighten the screws as illustrated in the following figure.

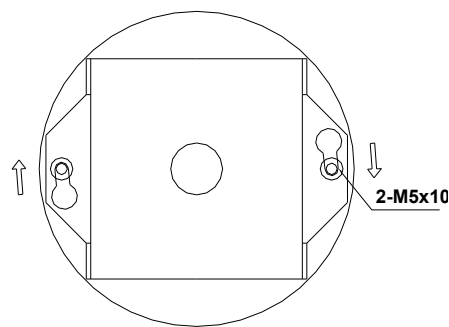

Dome drive mounting

Disconnect all wires of the speed dome prior to dismounting the dome drive.

After the lower dome bubble is carefully removed, loosen the two screws on each side of the dome drive and turn the dome drive counterclockwise. Disconnect wires from the connectors on the back of the dome drive while carefully separating the dome drive from housing.

### 2.4.2 Mount/Dismount Lower Dome

Before mounting the lower dome, please check that

1. Camera ID, protocol, baud rate, and alarm configuration are correctly set up with dipswitches.
2. All foam supporting materials in the speed dome housing are removed.

To prevent the lower dome bubble from fingerprints and scratches, please wear the provided gloves when handling the lower dome. To mount the lower dome, carefully match the screw holes on the back box and screws on the lower dome ring and tighten the screws (refer to the figure below).

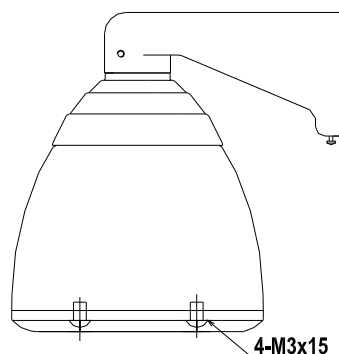

#### Lower Dome Mounting

Do the reverse for dismounting.

### 2.4.3 Mount to a Support

Send wires through the support and tighten the mounting screws on the support, or follow the manual of the support.

### 2.4.4 Install the Entire Unit

Always install the unit on a place with enough holding force to support the weight of the unit. The required minimum holding force is five times the total weight of the unit and the support. Due to the fact that installation of entire unit is subject to local administrative regulations, it is unable for us to provide detail instructions. Please make sure to follow all relevant laws or government regulations when installing the unit.

### 2.4.5 Power On and Speed Dome Self-Testing

Before turning the power on, please check that power supply is *12VDC* with enough current output and is connected correctly. **Wrong connection will result in permanent damage of the speed dome!**

When the power is turned on, the speed dome system will complete a self-testing procedure. The camera stops at the first preset after its self-testing procedure.

### 3. Operation





























































The speed dome system can be controlled by keyboard, matrix, and DVR (digital video recorder). Please also refer to the manual of corresponding control device to operate the speed dome system.







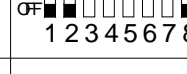
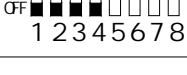
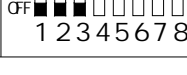

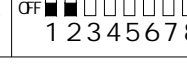























































The speed dome system has the following functions:































































1. When power is on, the speed dome goes through self-testing and then stops at the first preset.
2. Horizontal and vertical speeds can be controlled by keyboard joystick or computer mouse.
3. Camera zoom is adjustable with joystick or computer.
4. There are up to 228 presets that can be set up or be recalled. The numbers for preset positions range from #1 to #30 and from #59 to #256. Preset number #31 to #38 are reserved for 8 cruise routines (preset tours). #39 to #54 are reserved for special commands.
5. #31 to #38 presets are reserved for setup of 8 preset tours and they can not be set up as singular presets. One preset tour can have 2 to 64 presets. User may set up or recall any preset tour. For example, if you want to combine preset #2 and #3 to form a preset tour #31:
  - a. Enter the mode of setup #31 (refer to manual device manual)
  - b. Recall #2 preset
  - c. Recall #3 preset
  - d. Recall #31 to finish the setup mode for #31 and the preset tour is saved.
7. Preset tour can be recalled and dwell time on presets is adjustable.
8. Use control device to stop preset tour manually.
9. Presets #39 to #54 are for special commands of the speed dome.
  - #39: Start horizontal scan
  - #40: Use slow speed to recall preset or to scan
  - #41: Use middle speed to recall preset or to scan
  - #42: Use high speed to recall preset or to scan
  - #43: Set dwell time of preset tour to 3 seconds
  - #44: Set dwell time of preset tour to 5 seconds
  - #45: Set dwell time of preset tour to 7 seconds
  - #46: Enter camera OSD set up mode; then use zoom and focus keys on control device to set up camera parameters (for Sony and LG camera modules).
  - #47: Reserved
  - #48: Reserved
  - #49: Speed dome speed (horizontal and vertical) will be proportional to zoom
  - #50: Speed dome speed (horizontal and vertical) will not be proportional to zoom
  - #51: Display Camera ID (for Sony camera modules only)
  - #52: Do not display camera ID (for Sony camera modules only)
  - #53: Display zoom bar (for Sony camera modules only)
  - #54: Do not display zoom bar (for Sony camera modules only)







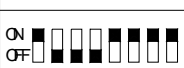
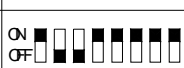





















































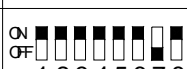

**Note: For some control devices, it may need to subtract one from the preset numbers referred above to perform the functions.**

## Appendix 1: Dome Camera Address Table

Address Switch Code	CAM ID	Address Switch Code	CAM ID	Address Switch Code	CAM ID	Address Switch Code	CAM ID
	001		017		033		049
	002		018		034		050
	003		019		035		051
	004		020		036		052
	005		021		037		053
	006		022		038		054
	007		023		039		055
	008		024		040		056
	009		025		041		057
	010		026		042		058
	011		027		043		059
	012		028		044		060
	013		029		045		061
	014		030		046		062
	015		031		047		063
	016		032		048		064

Address Switch Code	CAM ID	Address Switch Code	CAM ID	Address Switch Code	CAM ID	Address Switch Code	CAM ID
 065	065	 081	081	 097	097	 113	113
 066	066	 082	082	 098	098	 114	114
 067	067	 083	083	 099	099	 115	115
 068	068	 084	084	 100	100	 116	116
 069	069	 085	085	 101	101	 117	117
 070	070	 086	086	 102	102	 118	118
 071	071	 087	087	 103	103	 119	119
 072	072	 088	088	 104	104	 120	120
 073	073	 089	089	 105	105	 121	121
 074	074	 090	090	 106	106	 122	122
 075	075	 091	091	 107	107	 123	123
 076	076	 092	092	 108	108	 124	124
 077	077	 093	093	 109	109	 125	125
 078	078	 094	094	 110	110	 126	126
 079	079	 095	095	 111	111	 127	127
 080	080	 096	096	 112	112	 128	128

Address Switch Code	CAM ID	Address Switch Code	CAM ID	Address Switch Code	CAM ID	Address Switch Code	CAM ID
 129	129	 145	145	 161	161	 177	177
 130	130	 146	146	 162	162	 178	178
 131	131	 147	147	 163	163	 179	179
 132	132	 148	148	 164	164	 180	180
 133	133	 149	149	 165	165	 181	181
 134	134	 150	150	 166	166	 182	182
 135	135	 151	151	 167	167	 183	183
 136	136	 152	152	 168	168	 184	184
 137	137	 153	153	 169	169	 185	185
 138	138	 154	154	 170	170	 186	186
 139	139	 155	155	 171	171	 187	187
 140	140	 156	156	 172	172	 188	188
 141	141	 157	157	 173	173	 189	189
 142	142	 158	158	 174	174	 190	190
 143	143	 159	159	 175	175	 191	191
 144	144	 160	160	 176	176	 192	192

Address Switch Code	CAM ID	Address Switch Code	CAM ID	Address Switch Code	CAM ID	Address Switch Code	CAM ID
 193		 209		 225		 241	
 194		 210		 226		 242	
 195		 211		 227		 243	
 196		 212		 228		 244	
 197		 213		 229		 245	
 198		 214		 230		 246	
 199		 215		 231		 247	
 200		 216		 232		 248	
 201		 217		 233		 249	
 202		 218		 234		 250	
 203		 219		 235		 251	
 204		 220		 236		 252	
 205		 221		 237		 253	
 206		 222		 238		 254	
 207		 223		 239		 255	
 208		 224		 240		 255	Broadcast Code